

Technisches Datenblatt



Produktmerkmale

Kühlvitrine GN 3-1/1 nach oben öffnend

Modell

SAP -Code

00012124



SAP -Code	00012124	Nettogewicht / kg]	190.80
Netzbreite [MM]	1169	Power Electric [KW]	0.247
Nettentiefe [MM]	760	Wird geladen	230 V / 1N - 50 Hz
Nettohöhe [MM]	1688		

Technisches Datenblatt



Technische Zeichnung

Kühlvitrine GN 3-1/1 nach oben öffnend

Modell

SAP -Code

00012124

A= ELECTRICAL CONNECTION
 D= WATER DISCHARGE Ø16
 E= GAS CONNECTION Ø8 Ø10
 F= WATER BOX

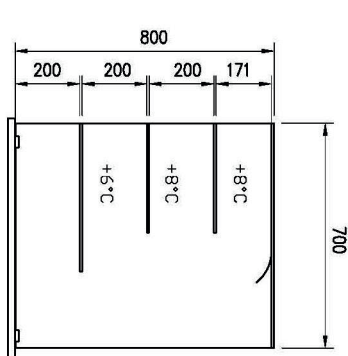
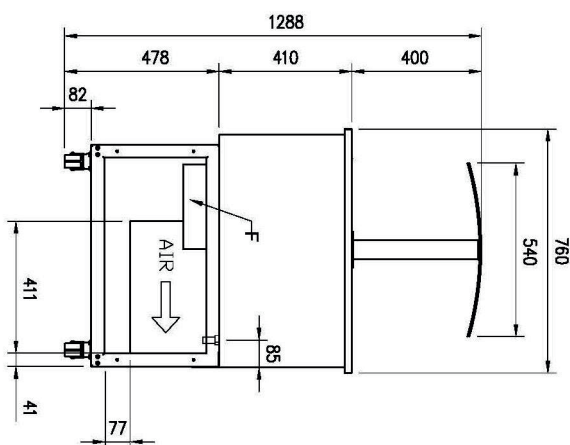
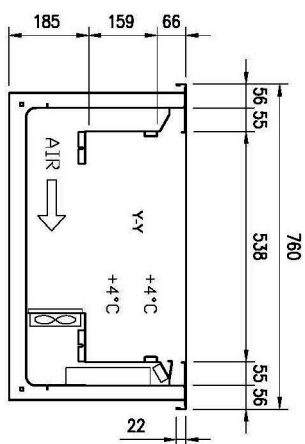
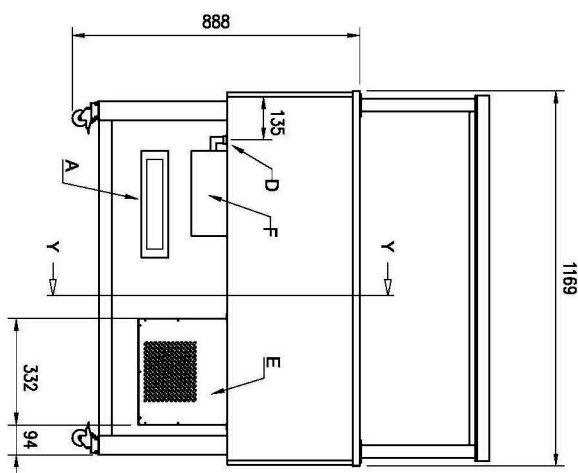
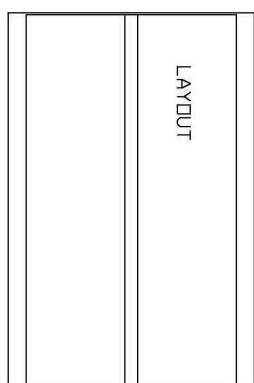

PLATINUM

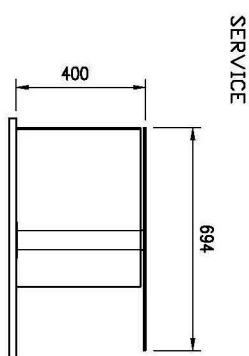

SERVICE

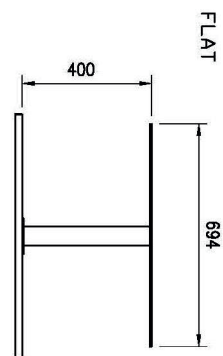

FLAT

Technisches Datenblatt

technische Parameter



Kühlvitrine GN 3-1/1 nach oben öffnend

Modell

SAP -Code

00012124

1. SAP -Code:

00012124

8. Bruttohöhe [MM]:

1830

2. Netzbreite [MM]:

1169

9. Bruttogewicht [kg]:

213.00

3. Nettentiefe [MM]:

760

10. Gerätetyp:

Neutrales Gerät

4. Nettohöhe [MM]:

1688

11. Power Electric [KW]:

0.247

5. Nettogewicht / kg:

190.80

12. Wird geladen:

230 V / 1N - 50 Hz

6. Bruttobreite [MM]:

1233

13. Kältemittel:

R290

7. Grobtiefe [MM]:

860